

Aesculap Surgical Instruments

Permagna-Set



Extra large instruments for obese patients

Permagna-Set



Adipositas Permagna – extreme obesity of the patients often presents surgeons with a problem: The available instruments are too short.

With the "Permagna Set" we have, in collaboration with Professor Müller of Bad Mergentheim and Professor Kieback of Aue, created a series of instruments long enough even for patients who take a size **"XXL"**.

Think Surgical Instruments. Think Aesculap.

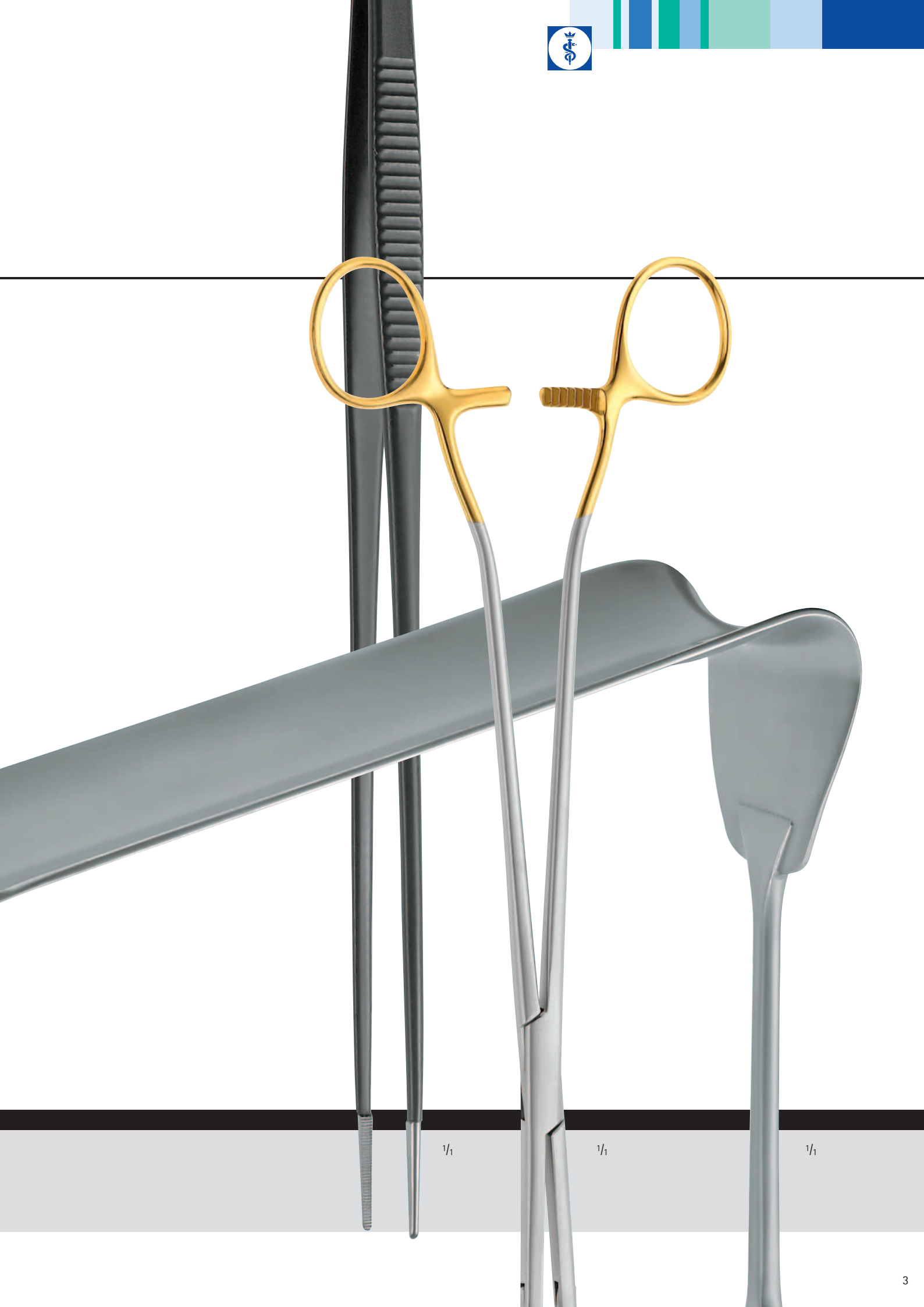

1/1

1/1

1/1

Permagna-Set

Single Use Scalpels and Handles



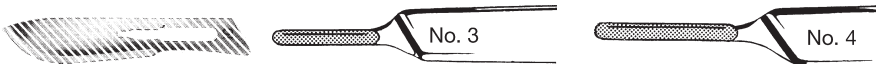

1/2

BB175R

Scalpel handle
No. 3 XL
250 mm
10"



1/2

BB087R

Scalpel handle
No. 4 XL
250 mm
10"



1/2

BA311SU

Single use scalpel
Fig. 11
230 mm
9"



1/2

BA323SU

Single use scalpel
Fig. 23
230 mm
9"

Permagna-Set Scissors

Dissecting Scissors

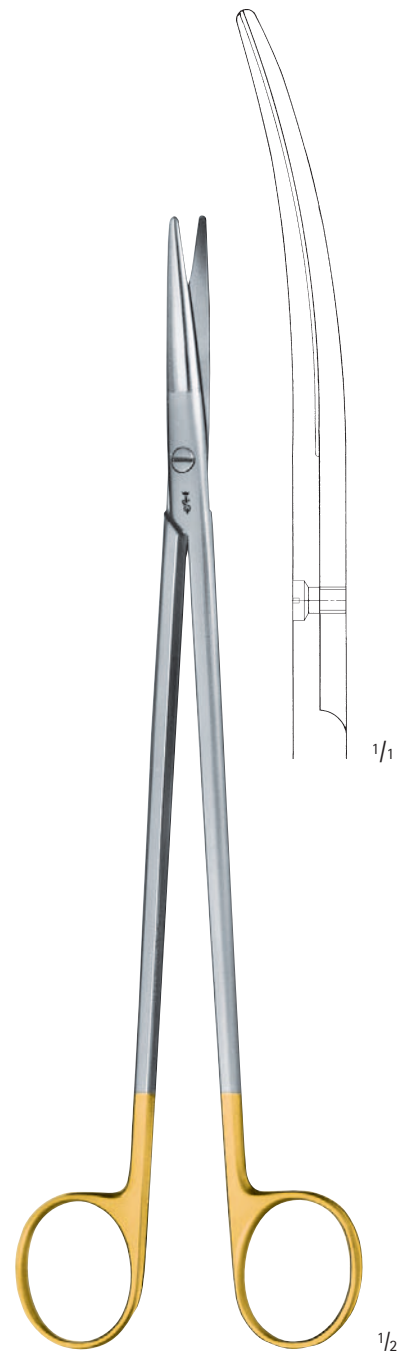

BC289R

NELSON-METZENBAUM (MC INDOE)
DUROTIP® dissecting scissors
300 mm
12"



BC614R	BC619R	BC625R
305 mm	305 mm	350 mm
12 1/2"	12 1/2"	14"

BC614R – BC625R

NELSON-METZENBAUM
Dissecting scissors

BC285R

NELSON-METZENBAUM
DUROTIP® dissecting scissors
350 mm
14"

BC285B

NELSON-METZENBAUM
NOIR® dissecting scissors
350 mm
14"

Permagna-Set Scissors

Dissecting Scissors



BC951R
300 mm
12"

BC953R
355 mm
14"

BC951R – BC953R

METZENBAUM
Supercut dissecting scissors

BC938R

MAYO
Supercut dissecting scissors
305 mm
12"

BC299R

WERTHEIM
DUROTIP® dissecting scissors
350 mm
14"

Uterine and Dissecting Scissors

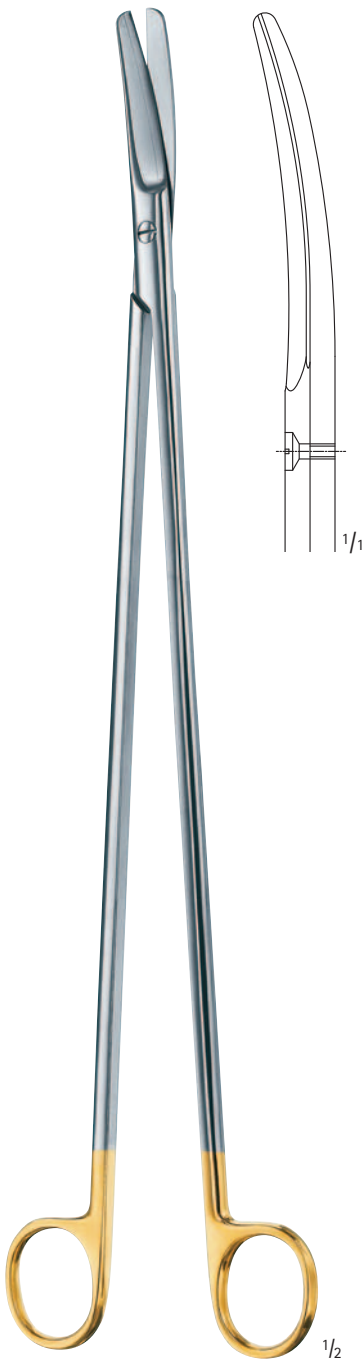

BC292R

SIMS
Uterine scissors
350 mm
14"

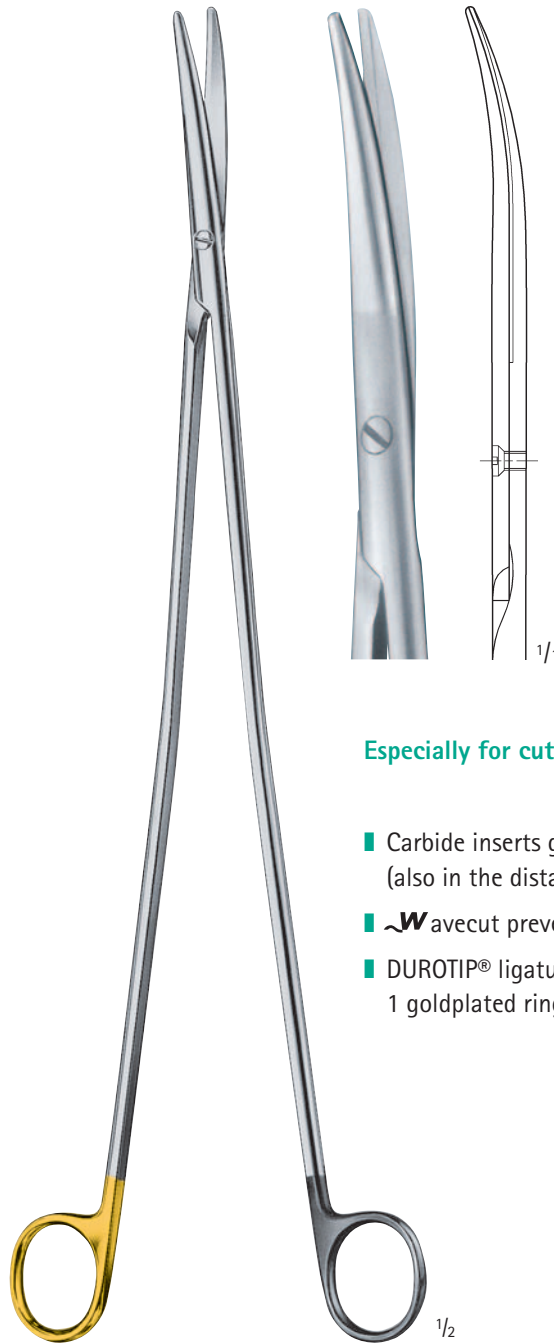

BC298W

DUROTIP® **W**avecut ligature scissors
350 mm
14"

Especially for cutting suture materials

- Carbide inserts guarantee permanent cutting edge (also in the distal area of the blades)
- **W**avecut prevents suture materials from slipping out
- DUROTIP® ligature scissors are identified by 1 goldplated ring

Permagna-Set Scissors

Scissors for Deep Operations and for Gynecology



BC766R

KIEBACK
Parametrium scissors, curved to side,
with 1 probe pointed blade
350 mm, 14"



BM976R	BM977R
270 mm	350 mm
13 3/4"	14"

For use with BC766R

BM976R – BM977R

UCHIDA (MODIF. N. BURKE)
Uretral spoon to be use with
BC766R

Rectal scissors



BC623R

STELZNER
Rectal scissors
310 mm
12½"

BC617R

Rectal scissors
325 mm
13"

BC627R

MÜLLER
Rectal scissors, s-shaped
325 mm
13"

Permagna-Set Forceps

Dissecting und Tissue Forceps, Suture Forceps

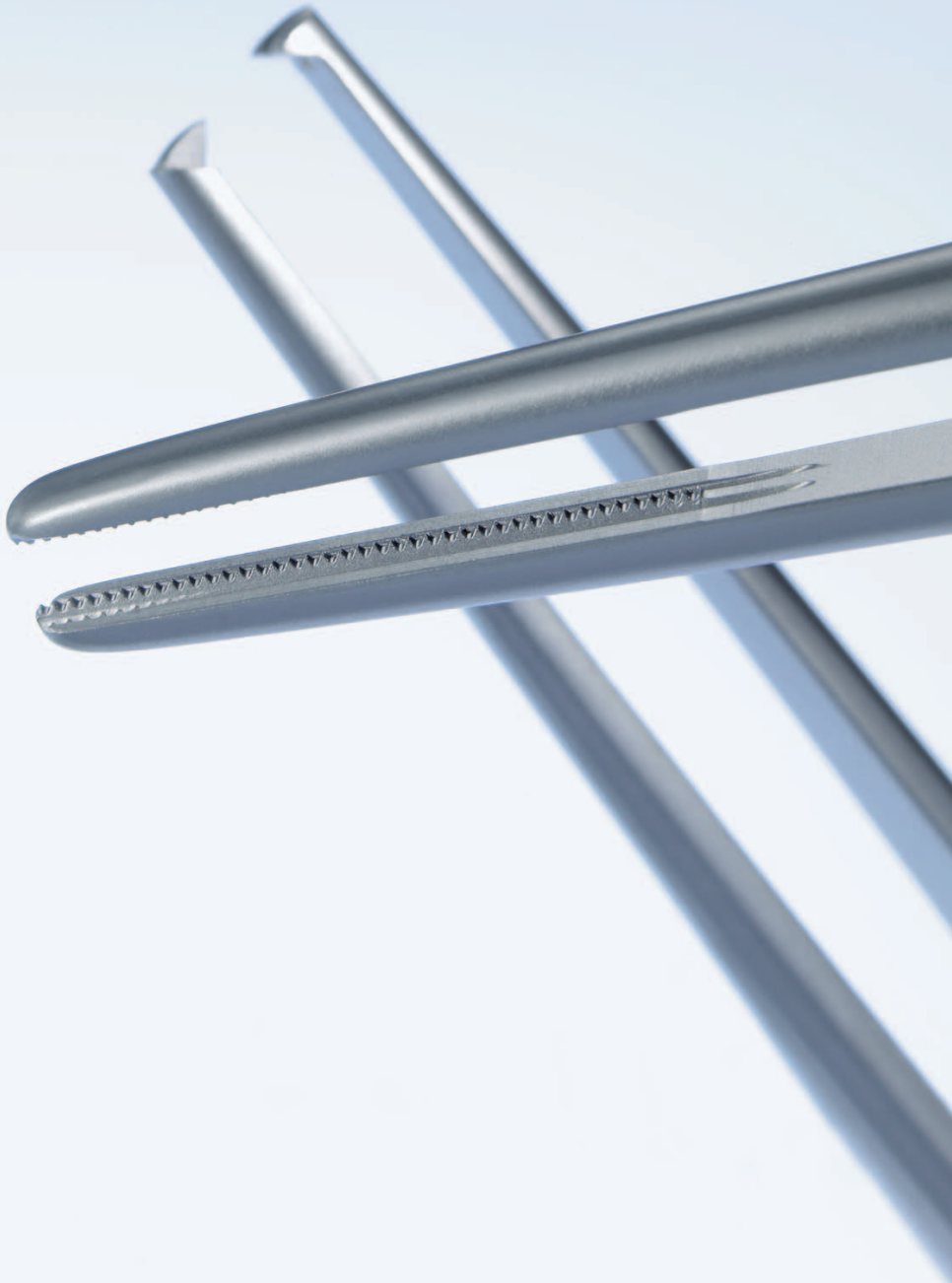

2.3 mm 4.8 mm

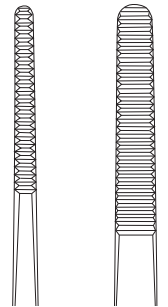

BD033R	BD053R
305 mm	300 mm
12"	12"

1/2

BD033R – BD053R

Dissecting forceps



1/2

2.2 mm	3.9 mm	3.9 mm
BD543R	BD563R	BD564R
300 mm	300 mm	350 mm
12"	12"	12"

1/1

BD543R – BD564R

Tissue forceps

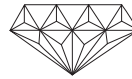

1/2



1/1

BD185R

Suture forceps

300 mm

12"

Permagna-Set Forceps

Atraumatic Forceps

ATRAUMATA®

Toothing DE BAKEY

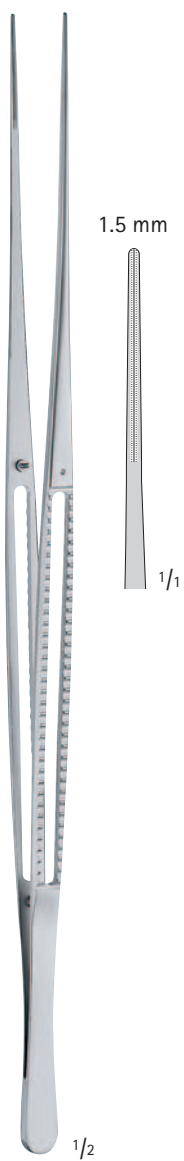

FC418R

DE BAKEY
Ultra light forceps
300 mm
12"

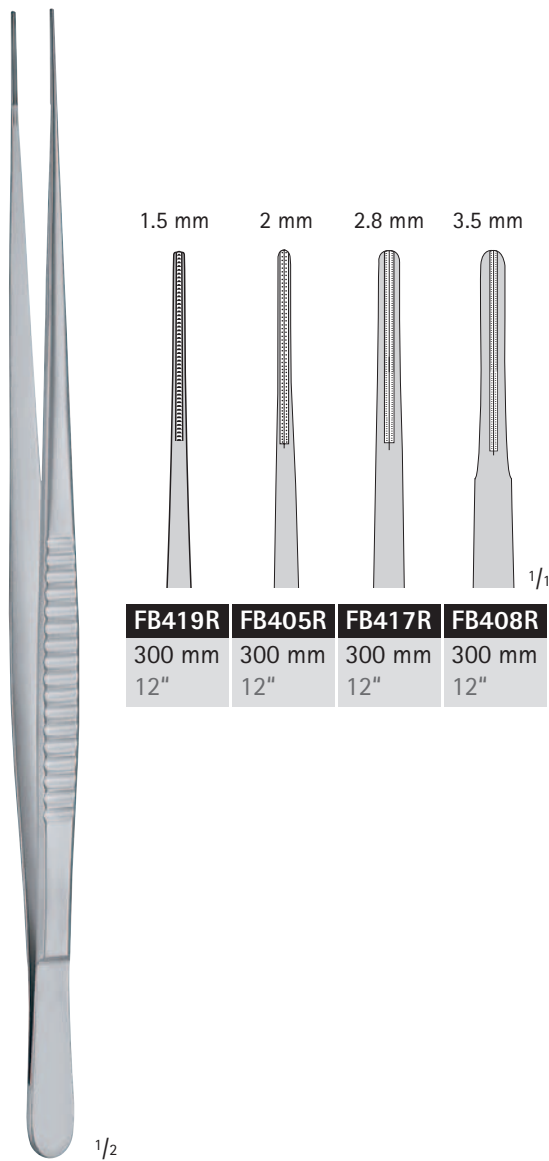

FB405R – FB419R

DE BAKEY
Forceps
300 mm
12"

FB419R	FB405R	FB417R	FB408R
300 mm	300 mm	300 mm	300 mm
12"	12"	12"	12"



Monopolar Forceps, insulated for Electro Surgery

ARAUMATA®

Toothing DE BAKEY



1/2



1/2



1/2



4 mm



1/1

BD854R

Forceps, insulated
300 mm
12"

BD857R

Forceps, insulated
1 x 2 teeth
300 mm
12"

BD860R

Forceps, insulated
300 mm
12"

GK033R

Monopolar forceps
insulated
350 mm
14"

Permagna-Set Forceps

BipoJet, bipolar Forceps for Electro Surgery



GK895R

BipoJet forceps
partly insulated tip
300 mm
12"

















GK885R

BipoJet forceps
fully insulated tip
300 mm
12"

Bipolar connection cables

Equipment side

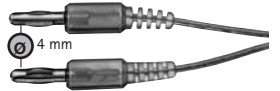
Instrument side – Aesculap

<p>Aesculap, ACMI, Berchtold, Martin, Wolf</p> <p>GN073 3,5 m</p> <p>GN077 5,0 m</p>			<p>▬▬ Tab connector</p>
<p>GK200 Aesculap, ACMI, Codman, Conmed, Olympus, Valleylab 3,5 m</p>			<p>▬▬ Tab connector</p>
<p>GK216 Erbe, Storz 3,5 m</p>			<p>▬▬ Tab connector</p>
<p>GK217 Codman 3,5 m</p>			<p>▬▬ Tab connector</p>
<p>GK193 Aesculap, Bowa, EMC, Lamidey, Erbe VIO, Söring, Valleylab 3,5 m Pin distance 29 mm</p>			<p>▬▬ Tab connector</p>
<p>GK202 Aesculap 3,5 GK020, GK021, GK030, GK034, GK050, GK051</p>			<p>▬▬ Tab connector</p>
<p>GK211 Aesculap, ACMI, Codman, Conmed, Olympus, Valleylab 3,5 m, Single use</p>			<p>●● Round pin plug ▬▬ Tab connector for forceps with Aesculap tab and round pin connectors</p>

Permagna-Set Forceps

Sponge and Grasping Forceps



BF078R

SIMS-MAIER
Sponge and Grasping forceps
350 mm
14"



BF065R

ULRICH-AESCULAP
Sponge forceps
350 mm
14"



BF135R
320 mm
12 3/4"

BF136R
320 mm
12 3/4"

BF135R – BF139R

KELLY
Sponge forceps

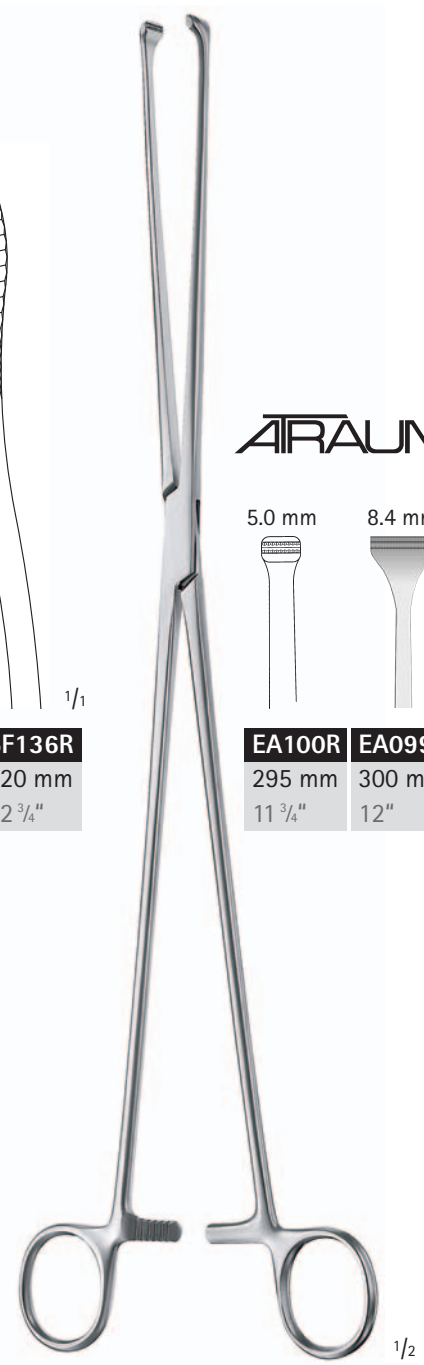

TRAUMATA®

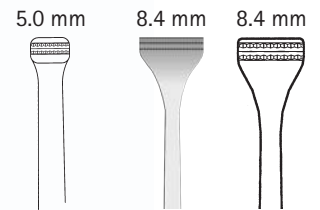

EA100R
295 mm
11 3/4"

EA099R
300 mm
12"

EA101R
350 mm
14"

EA099R – EA101R

ALLIS
Grasping forceps

Permagna-Set Clamps

Hemostatic Forceps

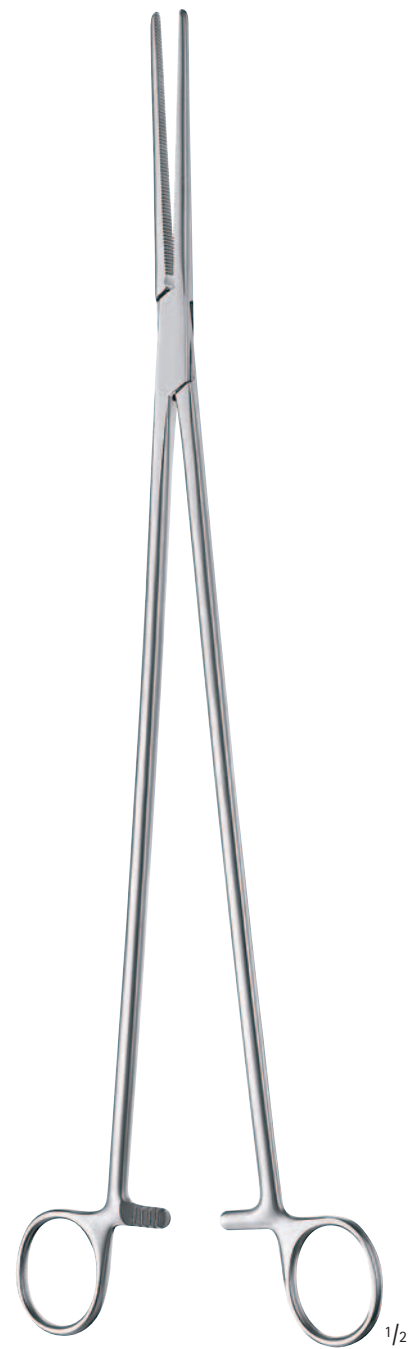

BH456R – BH475R

PEAN
Hemostatic forceps

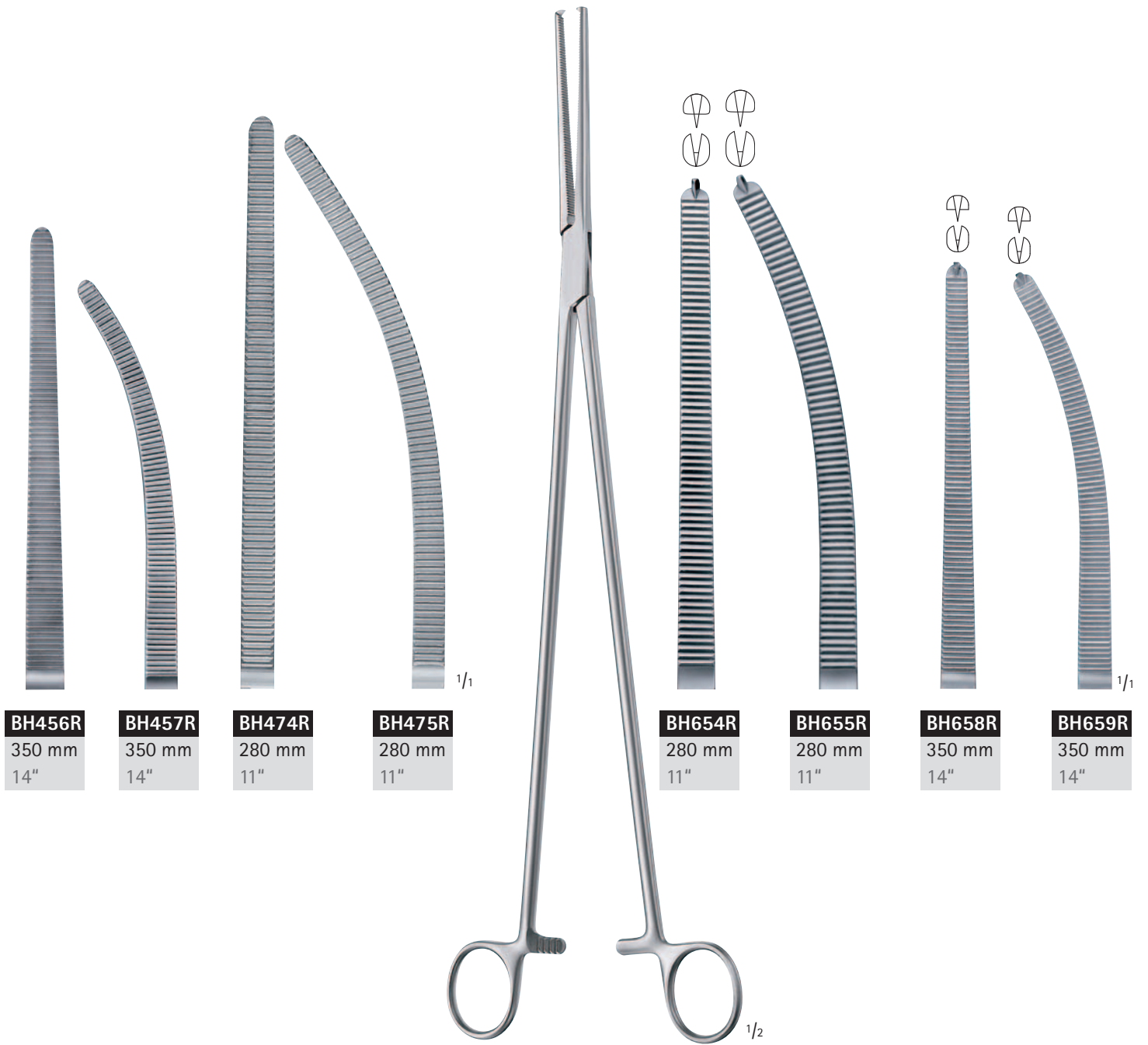

BH456R
350 mm
14"

BH457R
350 mm
14"

BH474R
280 mm
11"

BH475R
280 mm
11"

BH654R
280 mm
11"

BH655R
280 mm
11"

BH658R
350 mm
14"

BH659R
350 mm
14"

BH654R – BH659R

KOCHER-OCHSNER
Hemostatic forceps

Permagna-Set Clamps

Dissecting and Ligature Clamps



¹/₂



BJ047R
300 mm
12"



BJ048R
290 mm
12 1/2"



BJ130R
350 mm
14"

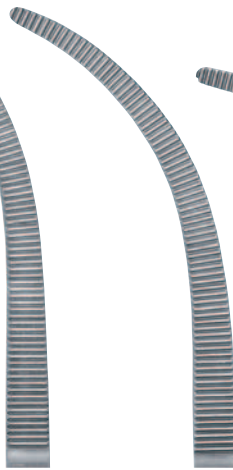

BJ131R
350 mm
14"

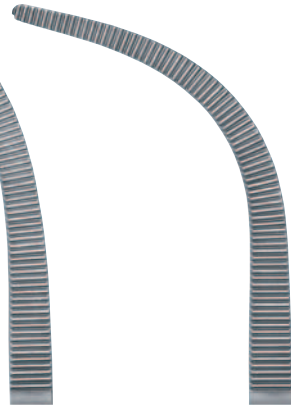

BJ132R
350 mm
14"

¹/₁

BJ047R – BJ132R

ZENKER
Dissecting clamps



BJ106R

GEMINI
Dissecting clamp
280 mm
11"



BJ090R	BJ091R	BJ096R
295 mm	295 mm	300 mm
11 3/4"	11 3/4"	12"

BJ090R – BJ096R

OVERHOLT
Dissecting clamps
delicate pattern

Permagna-Set Clamps

Hysterectomy, Vaginal, Dissecting and Ligature Clamps

ARAUMATA[®]

Toothing DE BAKEY

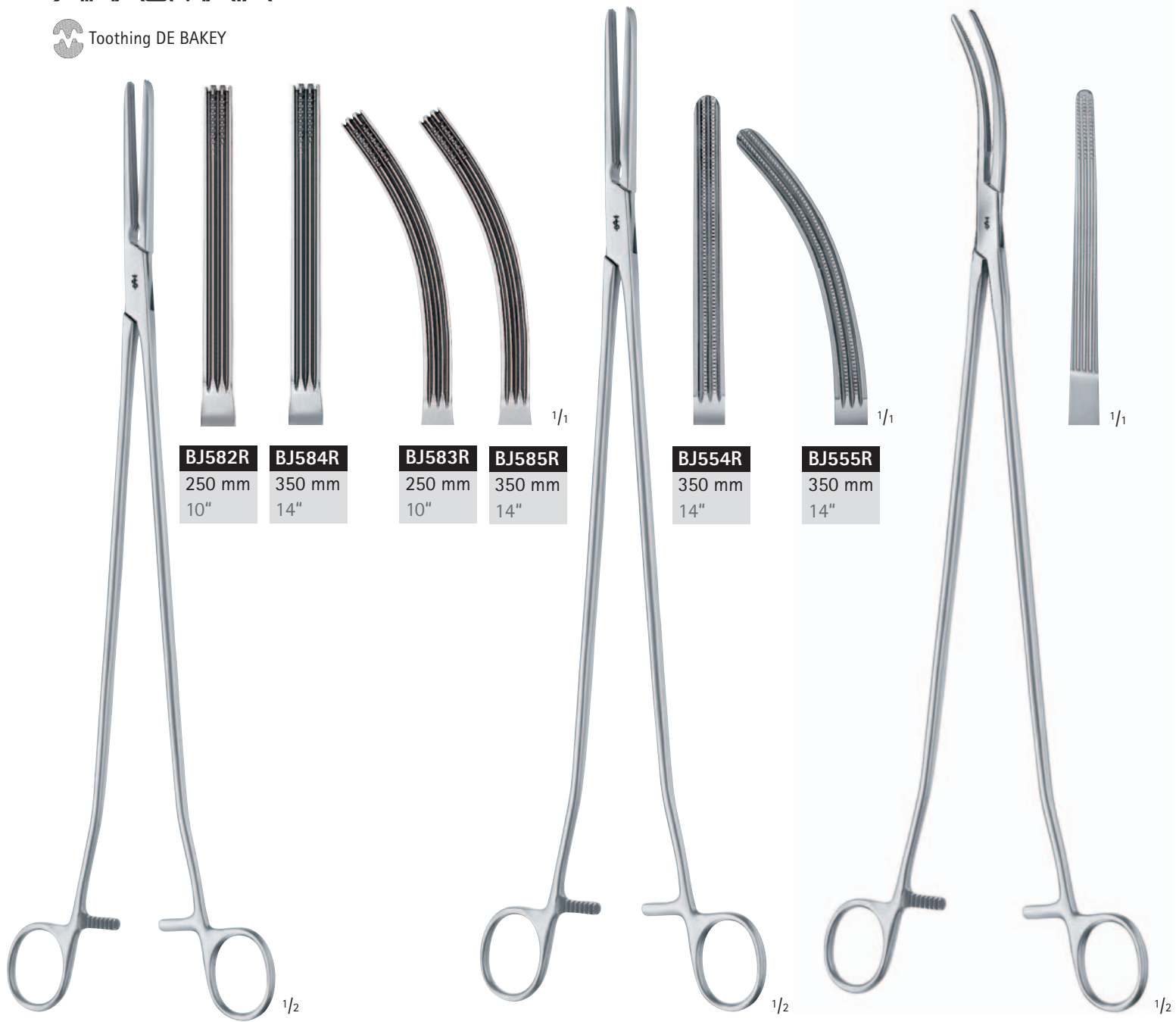

BJ582R – BJ585R

KIEBACK
Hysterectomy and
vaginal clamps

BJ554R – BJ555R

Hysterectomy clamps
350 mm
14"

BJ076R

KIEBACK
Dissecting and Ligature clamps
350 mm
14"

Hemostatic, Peritoneum and Hysterectomy Clamps

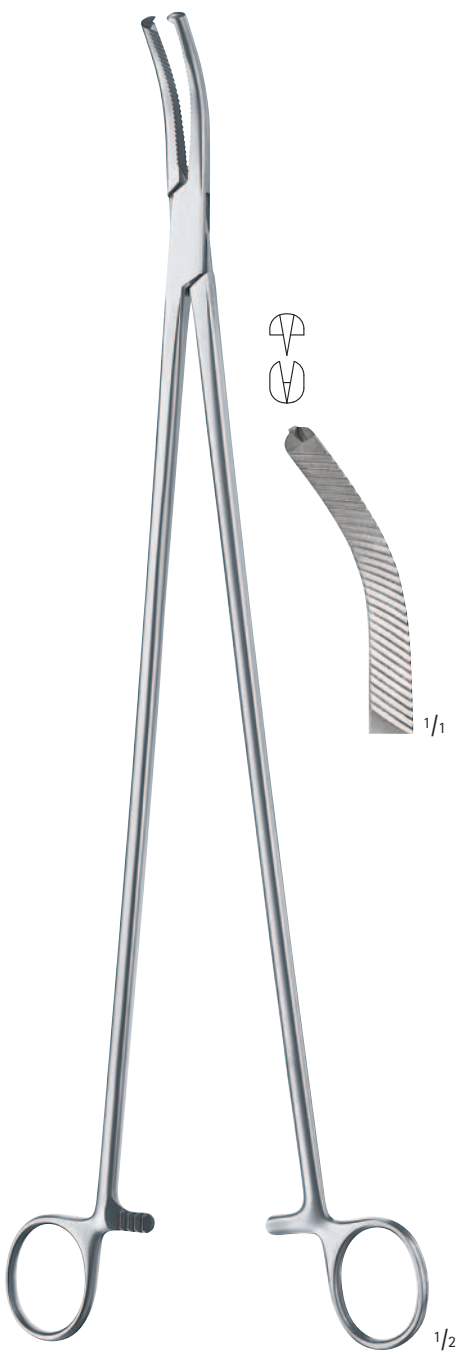

BJ515R

WERTHEIM
Hysterectomy and
hemostatic clamp
350 mm, 14"

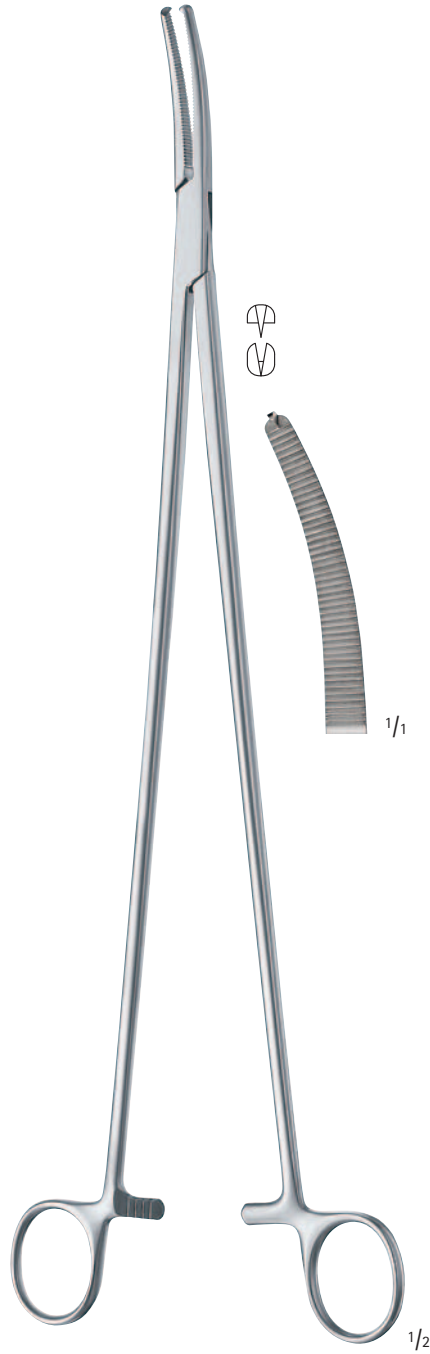

BJ528R

HOLZBACH
Hysterectomy and
hemostatic clamp
350 mm, 14"

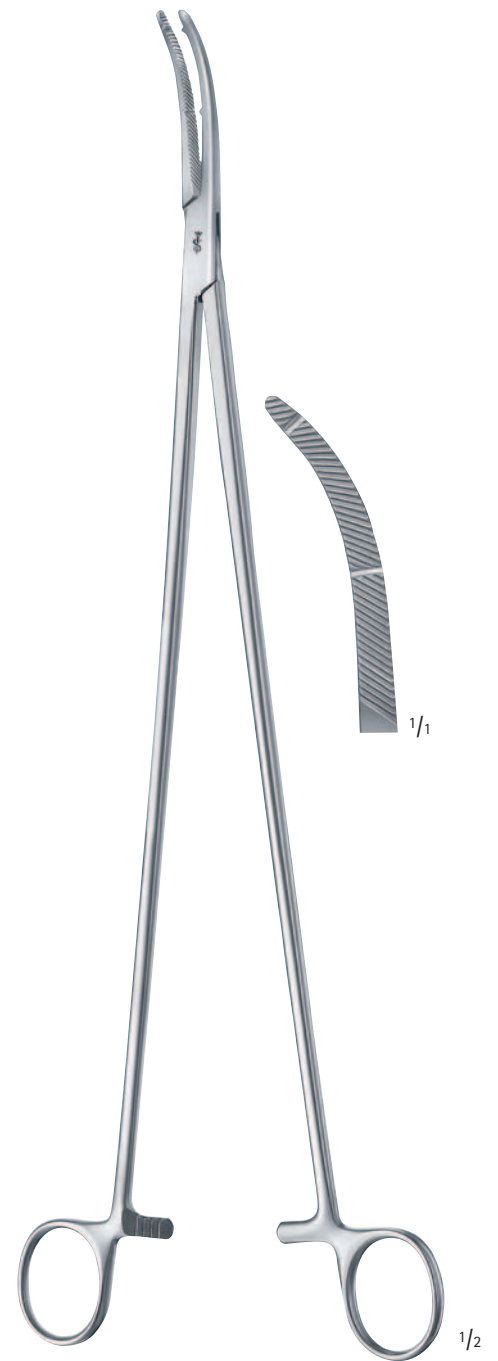

BJ529R

HEANEY MODIF.
Peritoneum and
hysterectomy clamp
350 mm, 14"

Permagna-Set Clamps

Parametrium Clamps



BJ562R
350 mm
14"

BJ563R
350 mm
14"

BJ562R – BJ563R

BURKE
Parametrium clamp

BC765R

KIEBACK
Parametrium scissors
350 mm
14"

Rectum Anastomosis Clamp



AIRAUMATA®

 Toothing DE BAKEY

EA356R

MÜLLER
Rectum anastomosis clamp
for deep rectum surgery
275 mm, 10 3/4"

Permagna-Set Needle Holders

DUROGRIP® Needle Holders

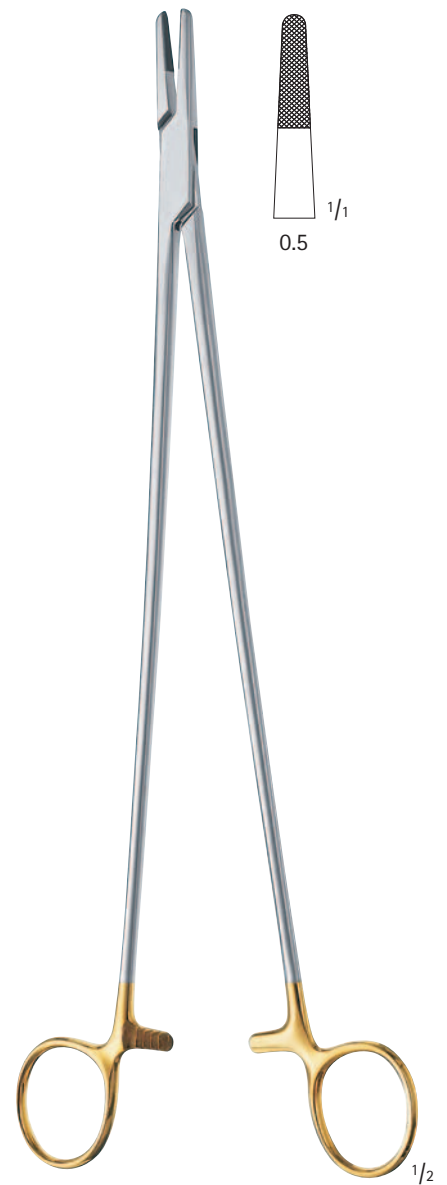

BM069R

HEGAR-MAYO
DUROGRIP® needle holder
300 mm
12"

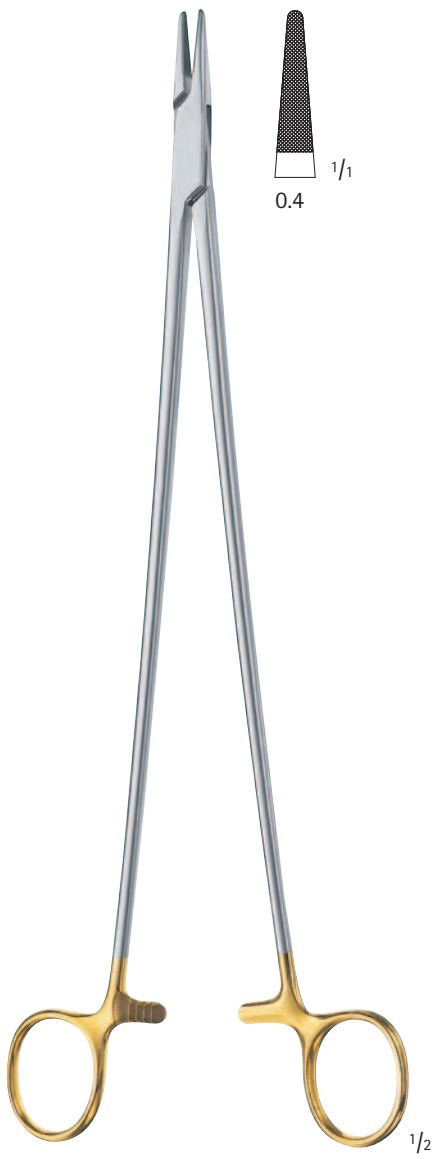

BM021R

CRILE-WOOD
DUROGRIP® needle holder
305 mm
12 1/2"

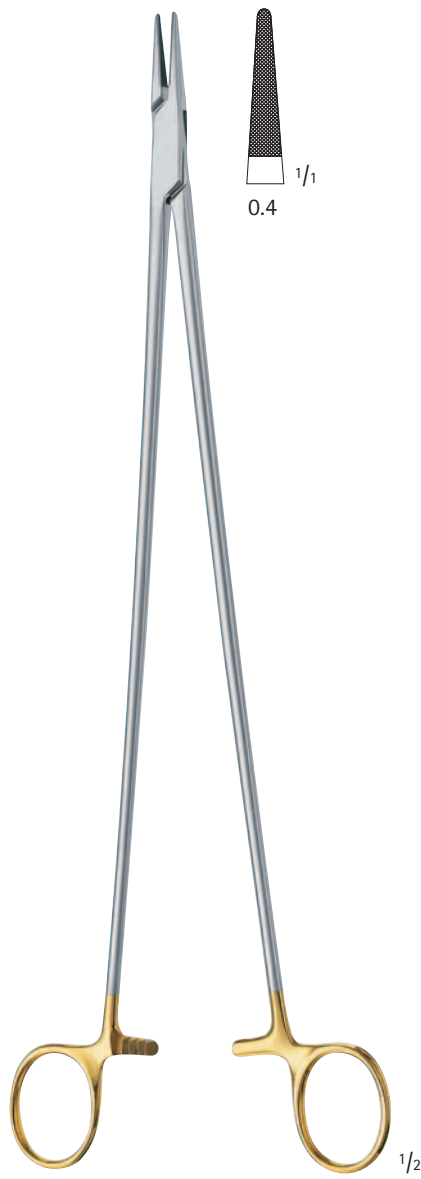

BM038R

DE BAKEY
DUROGRIP® needle holder
305 mm
12 1/2"

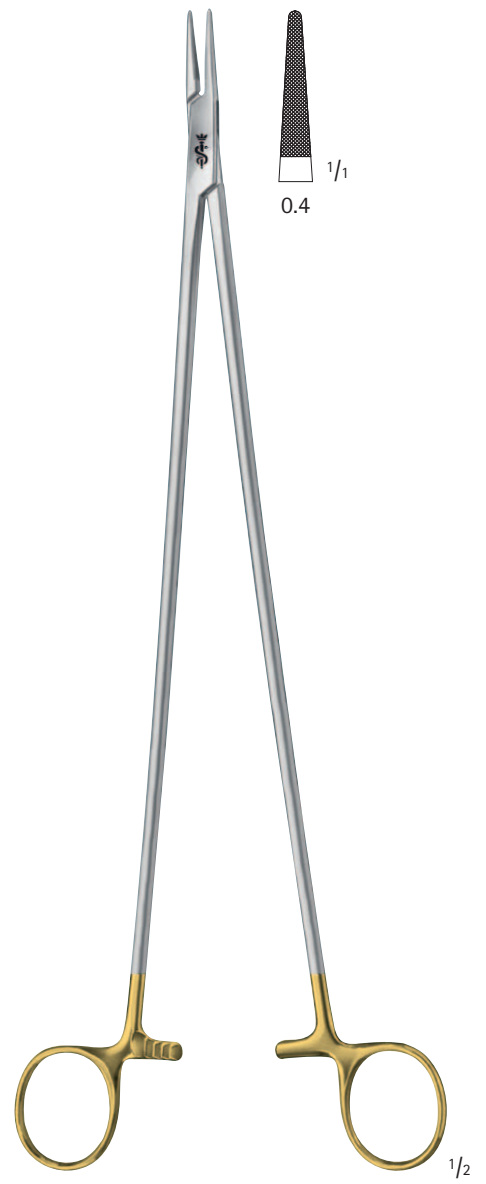

BM040R

DE BAKEY
DUROGRIP® needle holder
slender pattern
305 mm, 12 1/2"

Permagna-Set Needle Holders

DUROGRIP® Needle Holders



BM089R

MÜLLER
DUROGRIP® needle holder
for deep rectum surgery
350 mm, 14"

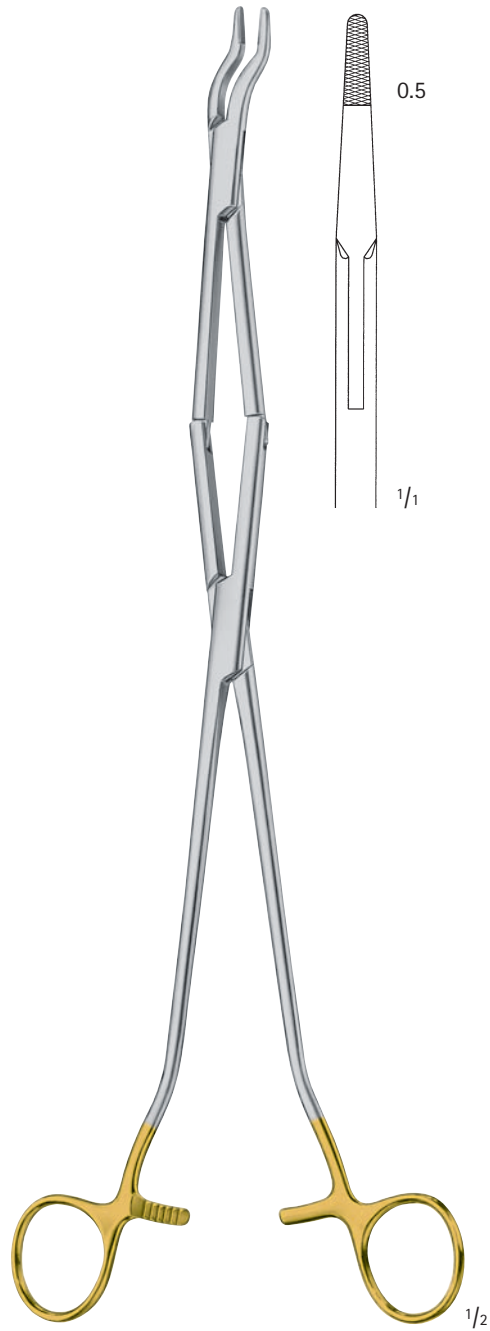

BM106R

MÜLLER
DUROGRIP® needle holder
for deep rectum surgery
350 mm, 14"

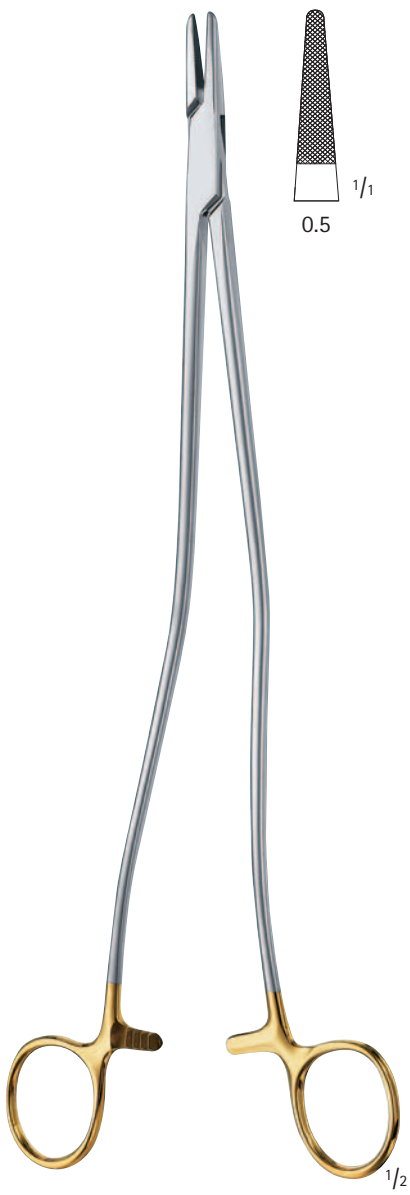

BM102R

WERTHEIM
DUROGRIP® needle holder
300 mm
12"

Permagna-Set

Retractors



BT513R

BRUNNER
Retractor
250 mm, 10"
180 x 30 mm*

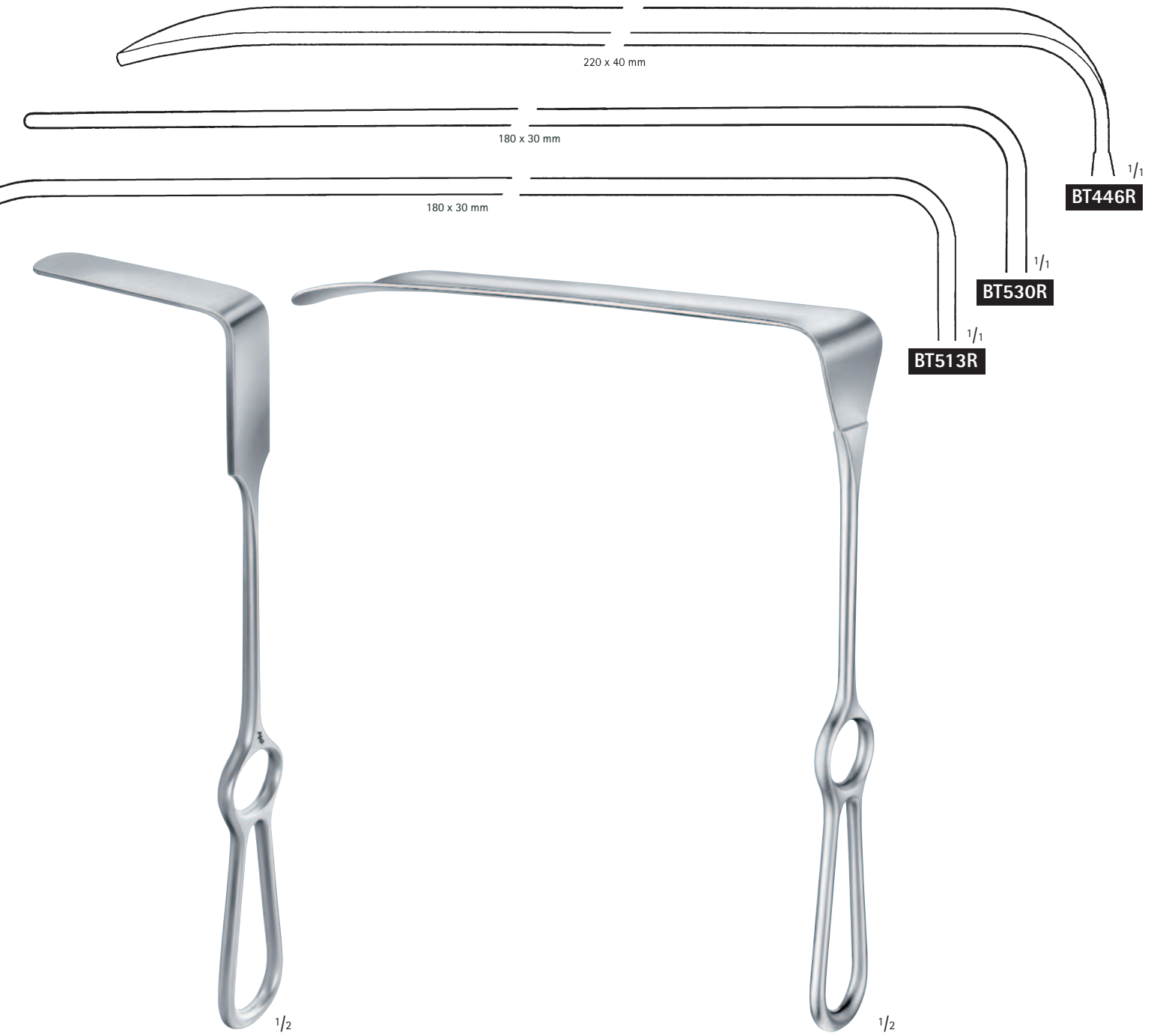

BT530R

BRUNNER
Retractor
275 mm, 10^{3/4}"
180 x 30 mm*

BT446R

HÖSEL
Retractor
250 mm, 10"
220 x 40 mm*

* depth x width

Permagna-Set

Retractors



BT740R

KÜMMEL
Retractor, malleable
285 mm
11 ³/₄"



BT732R

LERICHE
Retractor
275 mm
10 ³/₄"



BT607R

DEAVER
Retractor
Fig. 2 $\frac{1}{2}$
365 mm, 14 $\frac{1}{2}$ "

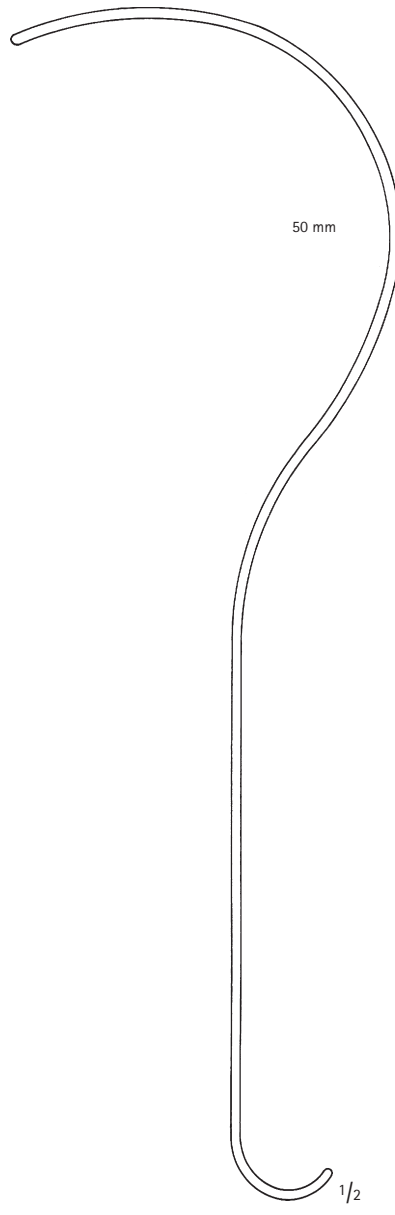

BT605R

DEAVER
Retractor
Fig. 4
310 mm, 12 $\frac{1}{4}$ "

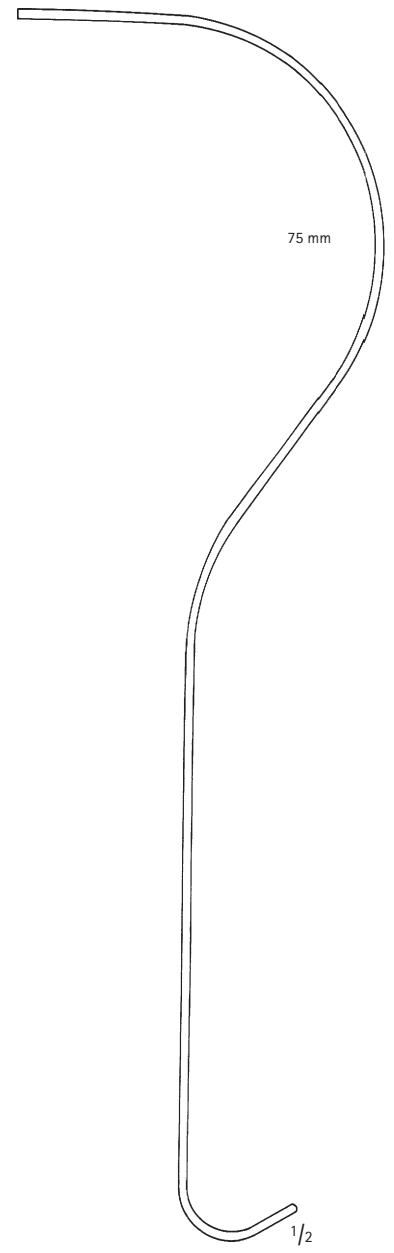

BT608R

DEAVER
Retractor
Fig. 5
320 mm, 12 $\frac{3}{4}$ "

Permagna-Set Retractors

Pelvis Retractors

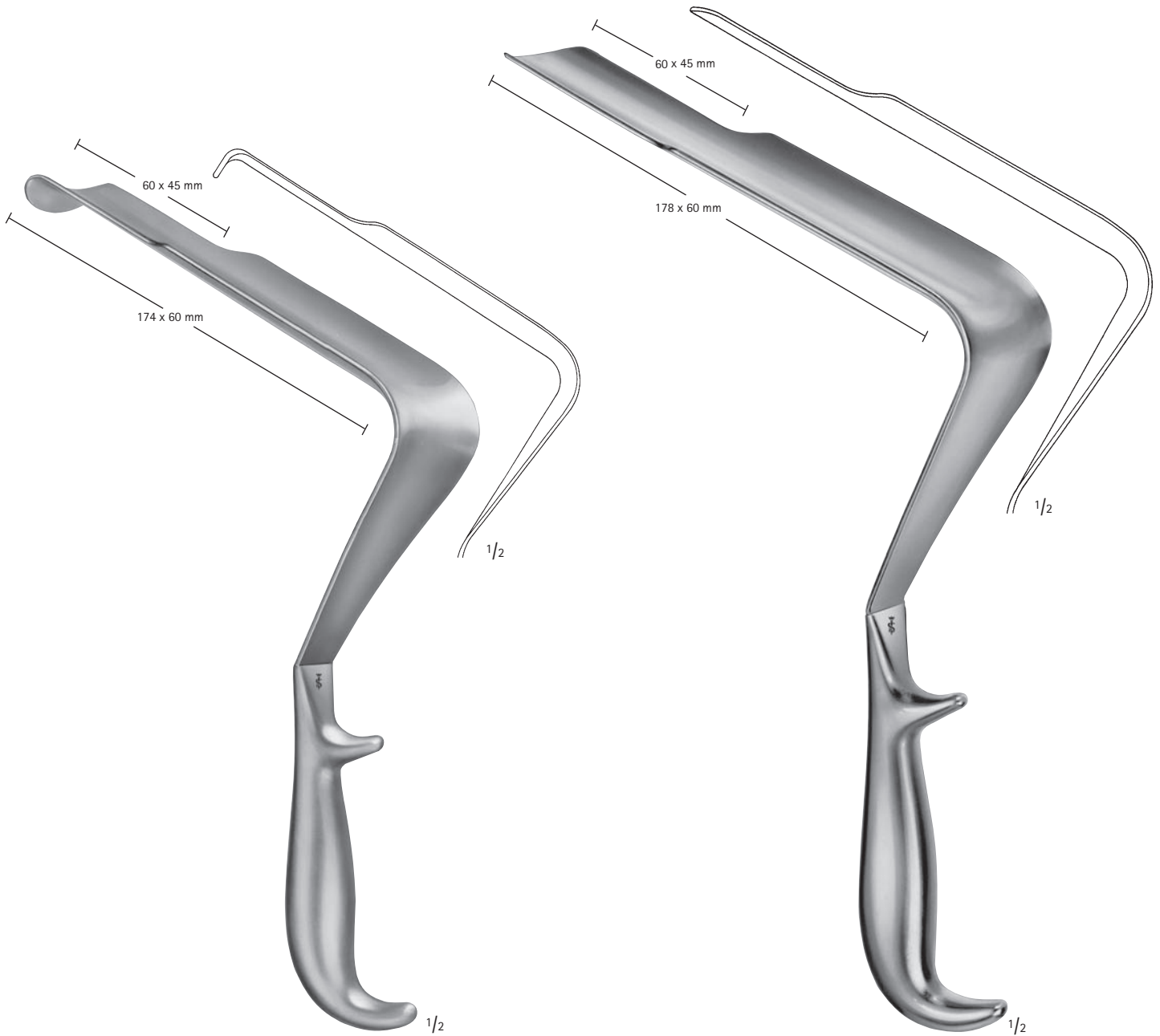

BT672R

ST. MARKS
Pelvis retractor
330 mm
13 1/8"

BT674R

ST. MARKS
Pelvis retractor
330 mm
13 1/8"



BT626R

MÜLLER
Pelvis retractor
270 mm
10 ³/₄"

Permagna-Set

Retractors



BT743R

MÜLLER
Retractor
270 mm
10 3/4"



BT756R	BT761R	BT762R	BT763R
12 mm	30 mm	40 mm	50 mm

$\frac{1}{2}$

BT756R – BT763R

RIBBON

Abdominal and intestinal spatulas

malleable

330 mm, 13 $\frac{1}{8}$ "



AESCULAP®

B | BRAUN
SHARING EXPERTISE

Aesculap AG

Am Aesculap-Platz
78532 Tuttlingen
Germany

Phone +49 7461 95-0
Fax +49 7461 95-2600

www.aesculap.de

All rights reserved. Technical alterations are possible. This leaflet may be used for no other purposes than offering, buying and selling of our products. No part may be copied or reproduced in any form. In the case of misuse we retain the rights to recall our catalogues and pricelists and to take legal actions.